

Modeling ATSF Steel Waycars with InterMountain Kits

Peter Aue January 2010

InterMountain Railway Co recently introduced a new undecorated HO scale kit CCS1199 which permits modeling of ATSF steel waycars 1500 through 2000. The kit contains parts to model the above cars throughout their service life between the late 1920s and the late 1960s, when most remaining cars were rebuilt. Waycars 2101 through 2200 had different style roofwalks which are not included in the kit but can be scratchbuilt fairly easily. For the casual observer all steel waycars 1500 through 2200 look more or less identical, but there were many differences not only as built but even more so as modified during their service life.

It is my intention to complement the instruction sheets provided by InterMountain in the car kits with prototype information and with additional details to ease assembly, painting and lettering of the models. Suggestions for enhancements like interior lighting etc. are also included.

My research is focused on 1950, the year I model. However many of my findings are applicable for other periods and hopefully fellow modelers will find some of them beneficial.

The Prototypes

This steel caboose for the Atchison, Topeka and Santa Fe Railway was built by American Car and Foundry, in multiple orders, from 1927 to 1931. They became the standard mainline 'way car' on the railroad, and served into the 1960's. Over the years numerous changes were made to the cars, notably the addition of AB brake systems, taller hand railings at the ends, and the addition of electric lighting and radio equipment.

Santa Fe Steel Caboose Cars Built 1927 - 1943 as built

Series	Builder/ Year Built	Brake	Brake Staff	Bottom Side Panels	Cupola Roof Walk Laterals	Tools Cellars	Uncoupling Arrangement	Trucks
1500-1649	AC&F 1927	K Type	Jemco (vert.)	2*	ACL	2 Wood	Imperial "N" top	Bettendorf
1650-1749	AC&F 1928	K Type	Ureco (vert.)	2*	ACL	2 Wood	Imperial "N" top	Bettendorf
1750-1874	AC&F 1929	K Type	Ajax	2*	ACL	2 Steel	Imperial "B" top	Bettendorf
1875-1978	AC&F 1930	K Type	Ajax	2*	FCL	2 Steel	Rotary bottom	Bettendorf
1979-2000	AC&F 1931	K Type	Ajax	2*	FCL	2 Steel	Rotary bottom	Bettendorf
2001-2100	ATSF 1942	AB Type	Ajax	4	FCL	2 Steel	Rotary bottom	Barber-Bettendorf
2101-2200	ATSF 1943	AB Type	Ajax	4	WEL	2 Steel	Rotary bottom	Barber-Bettendorf

* Prototype for InterMountain car

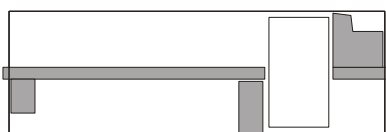

ACL - Alternate Cupola Laterals

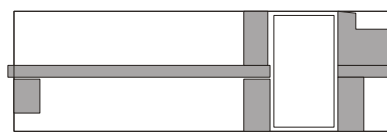

FCL - Full Cupola Laterals

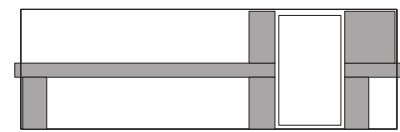

WEL - Wide End Laterals

Common to all cars as built:

Steel Underframe Base
 Swing motion trucks with leaf springs
 Galvanized radial riveted roof
 Wood roof walks
 Height of End Railing 30"
 Wheel Base 23' 11"
 Length Over End Sills 28' 2"

Major modifications during service life:

Ajax hand brakes for all cars (after mid 1950s)
 AB brakes for all cars (after mid 1950s)
 18" Wig Wags (highball signals) on some cars
 30" Wig Wags on many cars beginning 1940 through 1960s
 Radios with various antennas beginning 1946 (634 cars in 1961)
 Electric lights with battery box replacing tool cellar on left side (starting 1953 taking many years)
 End Railing raised to 42" (after late 1950s)
 Metal roofwalks replacing wood roofwalks

Painting:

Anti-slip Black: Roofs including cupola roofs when delivered, until 1950s on some cars
 Mineral Brown: Sides, ends, cupolas, underframes, trucks and hardware, roofs after ca 1945
 Black: Roofwalks on most cars, Handrails and grab irons on some cars until ca 1953
 White: Handrails and edges of steps beginning ca 1953
 Unpainted Galvanized Steel: Steel roof walks when new
 Light gray: Interior walls, ceiling and fixtures until 1945
 Light green: Interior walls, ceiling and fixtures after 1945
 Slate grey: Interior floor (or dark green until 1945)
 Dark blue: Early 18" Wig Wags
 Reefer yellow: Later 18" Wig Wags and all 30" Wig Wags

Lettering:

Reporting marks:	A.T. & S. F.	until 1938	White 9" Roman
	A.T.S.F.	1938 – 1943	
	ATSF	after 1943	
Numbers on sides			White 7" Roman
Numbers on ends			White 4" Roman
Number on cupolas (if used)			White 3" Roman
Repacking, repainting, airbrake service data			White 1" Roman (1" Gothic after 1959)
Round reflective emblems beginning in 1958			White/Black Scotchlite:

References:

Santa Fe Steel Way Cars by Mark Wilkouski – Warbonnet First Quarter 1999
 Caboose Cars of the Santa Fe Railway by Frank M. Ellington – Third Revision 1998
 Santa Fe Waycars by Stephen M. Priest – 2000
 Santa Fe Railway Painting & Lettering Guide Vol 1 by Richard H. Hendrickson - 1990
 Detailing Santa Fe Steel Caboose by Andy Sperandio – Model Railroader September 1991
 InterMountain Railway Company Santa Fe Early Steel Caboose by Jay Miller – Warbonnet Fourth Quarter 2009

Modeling

The InterMountain Railway ATSF Early Steel Caboose kit has been manufactured with the in-service detailing in mind. This caboose was used in the steam era, the transition years, and in the diesel era. Numerous additional parts are included in the kit, to enable the modeler to assemble the caboose for service in the era of his choice.

Please read these instructions carefully and familiarize yourself with the parts before beginning assembly. Many of the small parts are delicate. The preferred way to separate the parts from the sprue is by cutting with a sharp hobby knife or separating with de-spruing nippers. Plastic solvent cement like Plastruct Plastic Weld is recommended for assembly of undecorated styrene parts and a gap-filling cyanoacrylate adhesive (ACC) for non-styrene plastic parts, metals parts and painted parts and sub-assemblies.

Basic Assembly Procedure Without Enhancements

FLOOR and FRAME

Step 1. Remove any flash from the floor, and test fit the floor into the body. Note there are two locator pins under the door at one end of the body. These pins should align with the two locator holes in the one end of the floor. Set the body aside. Drill through coupler mounting screw holes with #56 or 1.2mm drill. Test-fit coupler box and coupler mounting screw. If coupler mounting screw extends above floor, file off excessive length. Assemble the stair treads to the stairwells at each end of the floor. The top of the tread has the textured surface and the underside lip is to the outside of the car.

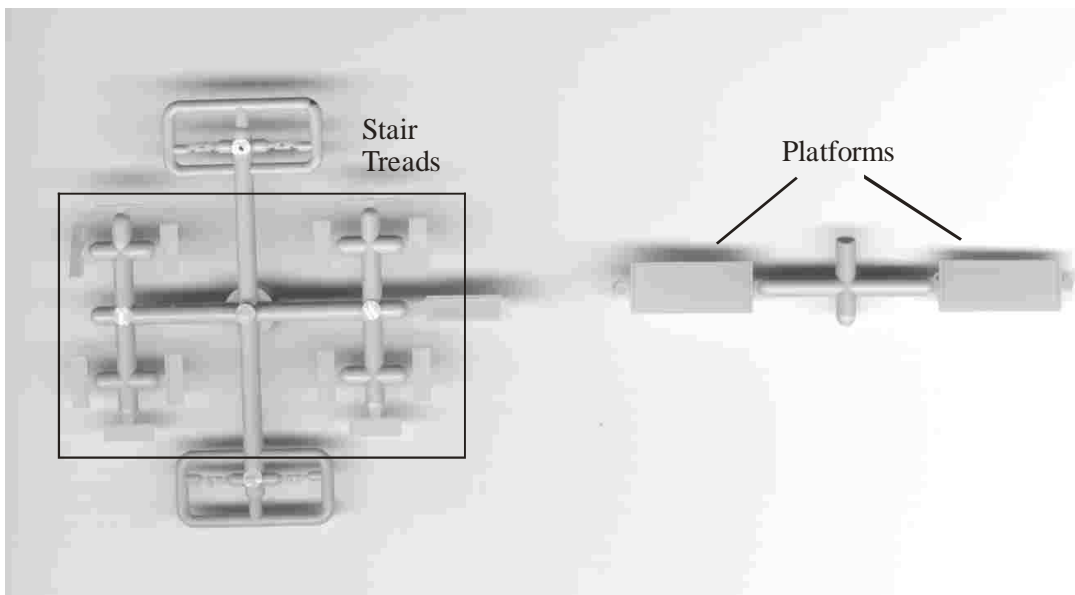

Step 2. Attach the platform to each end. Avoid closing with glue, the hole for the screw to attach the coupler, centered under each platform.

Step 3. Trim any flash from the under frame, and test fit it to the floor. Note one bolster has a square locator which aligns with the square opening in the floor. Both the K brake components and the AB brake components have been included in this kit. If the model will have the K brake, trim the two brackets that hold the AB reservoir, from the center of the under frame. If assembling with the AB brake components, clear the locator holes for the valve bracket, at the side edge of the floor with a #68 or .8mm drill.

Step 4. Assemble the train line to the center of the under frame. The train line consists of 2 pieces, a pre-shaped piece of brass wire and a small t-shape metal fitting with the locator hole. Slip the metal fitting onto the brass wire and position it correctly. Then attach the brass wire to the underframe with ACC.. The metal fitting will be glued to the brass wire later. Then attach the under frame to the floor.

Step 5. **For assembly with the K brake**, attach the K brake cylinder to the rectangular bracket at the center of the under frame. There is a notch in the bracket to locate the square pin molded to the cylinder.

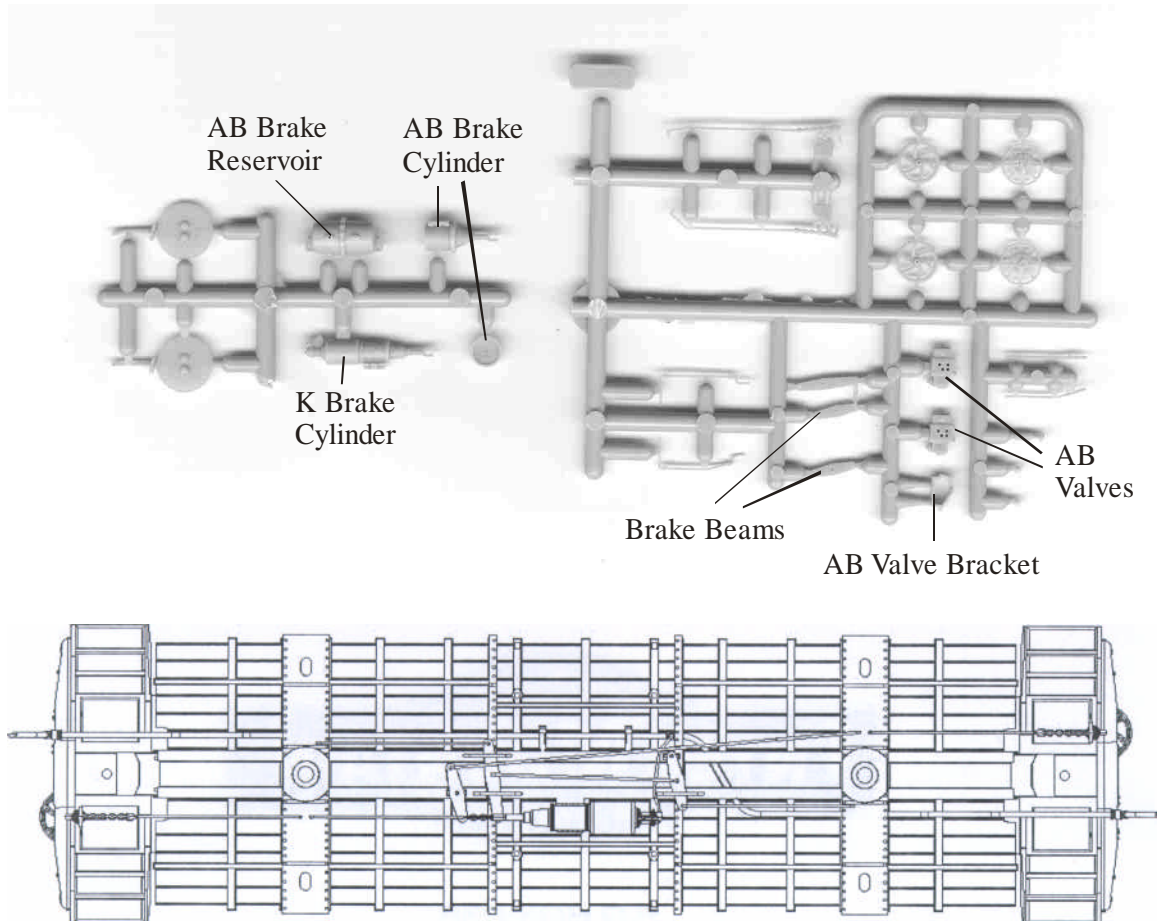

K BRAKE SYSTEM

Step 6. **For assembly with the AB brake**, attach the round end to the AB brake cylinder, and attach the cylinder to the rectangular bracket at the center of the under frame. There is a notch in the bracket to locate the square pin molded to the cylinder. Then attach the reservoir to the two brackets on the under frame opposite the brake cylinder. The two holes in the cylinder locate toward the under frame. Then attach the valve bracket to the floor in the two locator holes. The raised part of the bracket should be nearest the side edge of the floor. Then attach the valve to the bracket, with the four holes toward the under frame. Attention: AB brakes combined with wood tool cellars do not fit without some modification. Either the wood tool cellar must be shortened or the AB valve bracket must be moved away from the cellar not using the mounting holes.

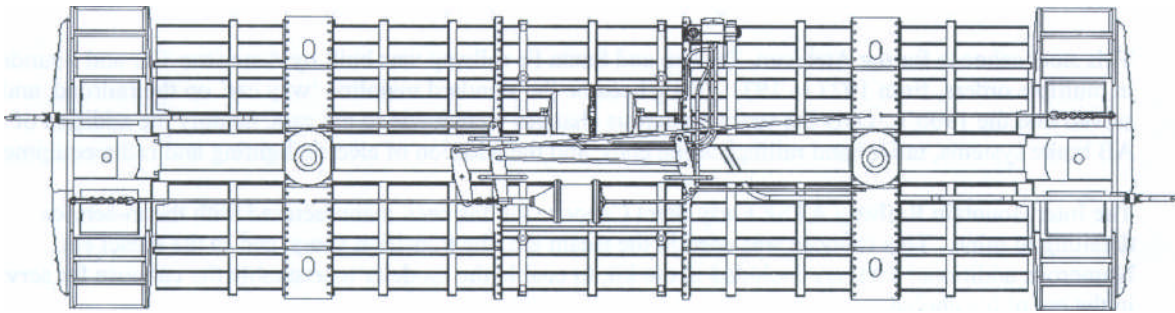

AB BRAKE SYSTEM

Step 7. Attach the wire supply line between the train line and the K cylinder or the AB valve. Note that there are different wire supply lines for K brakes and AB brakes.

Step 8. Attach the double brake lever into the clevis at the end of the brake cylinder. The end of the longer beam, at the chain, inserts into the clevis, and the center hole of the shorter beam locates on the pin at the tip of the bracket molded onto the under frame. Then attach the single brake beam with one end hole on the pin at the tip of the other bracket molded onto the under frame.

Step 9. Attach the remaining wire brake system parts. Also, the hand brake rods are connected from the ends of the shorter of the double brake lever to the bolsters.

Step 10. This kit includes end beams with three different end railings; 30" high with vertical hand brake, 30" high with AJAX mechanism, and 42" high with AJAX mechanism. The cars were originally manufactured with the 30" high end railings. Choose the end railings for the car, and attach the end beams at the three locator holes at each end with ACC. Attach the brake wheels to the end railings with ACC.

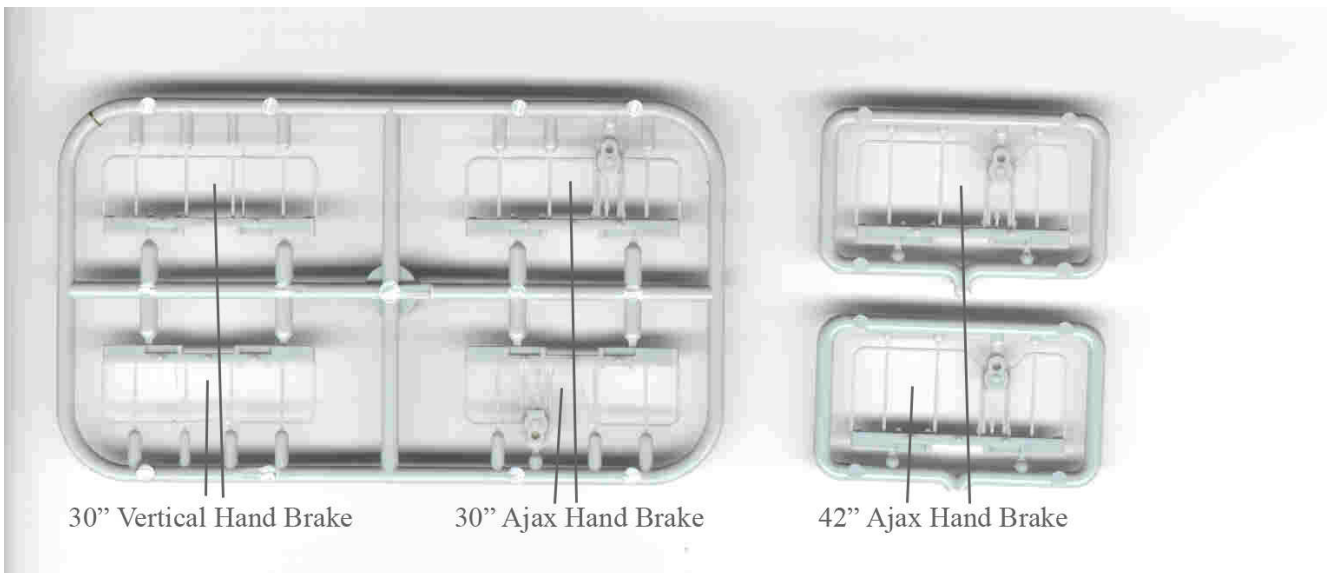

Step 11. There are two types of hand brake rods; one for the vertical hand brake, and one including a fulcrum for the AJAX mechanism. Choose the hand brake rods and attach them to the floor under each hand brake with ACC.

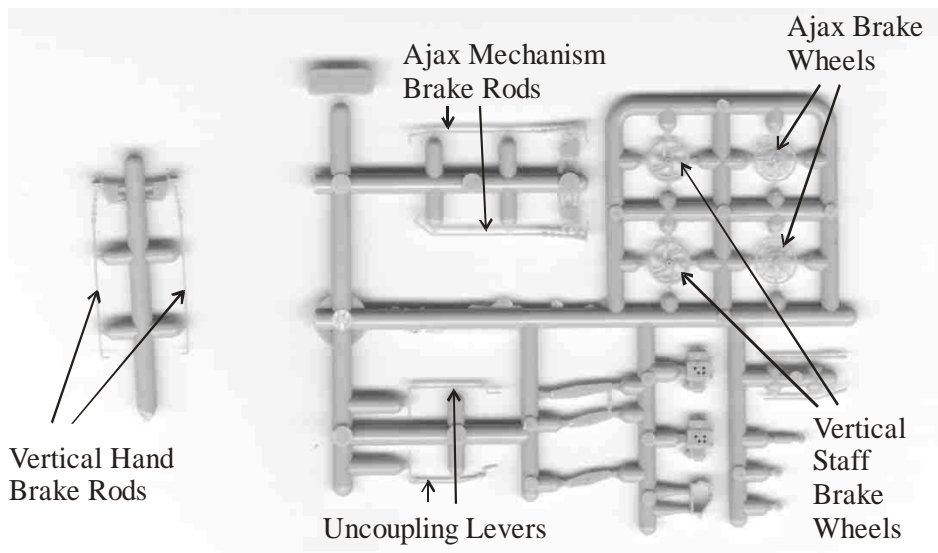

Step 12. The floor has been molded to accept the Kadee No. 78 coupler. Remove the Kadee No. 78 coupler box tops and only mount the coupler boxes to the floor at this time. Be careful not to loose the coupler springs inside the coupler boxes when disassembling the No. 78 coupler. Be careful that the screws do not push up through the end platforms. If the screws are too long, place washers under the screw heads.

Step 13. Attach the grab irons to the end of the floor.

Step 14. Attach the air hose to each end of the floor.

Step 15. Attach the coupler lift bar to each end beam. Note that the coupler lift bar in the kit is only suitable for the Imperial "N" top uncoupler for cars 1500-1874. When modeling later cars make and attach your own coupler lift bars with brass wire and eyebolts.

Set the assembled floor and frame aside for painting.

BODY

Step 16. Remove any flash from the body. There is a small round gate in the center of the roof that should be trimmed away. Clear the grab iron holes with a .016 in. dia. (#78) drill. Remove any flash from the cupola. Test fit the cupola to the roof, and then set the cupola aside.

Step 17. If desired, the inside of body and cupola should be painted at this time prior to any further assembly steps.

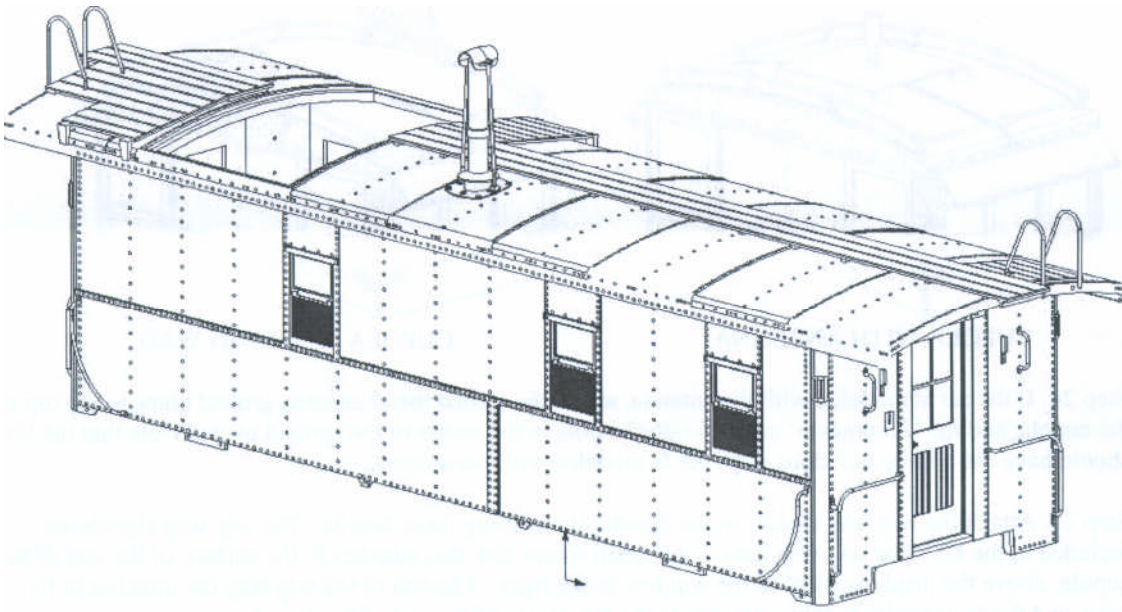

BODY ASSEMBLY - WALKS HALF ACROSS AT CUPOLA

Step 18. Attach the grab irons to the body.

Step 19. There are two types of smoke jack in the kit; a shorter one-piece version, and a two-piece version. Note there are two support wires for the smoke jack. Clear the holes for the support wires with a .016 in. dia. (#78) drill. Use the long two-piece version, and attach it into the locator holes in the roof. Discard the support wires provided in the kit and make your own 5/8" or 16mm long from .012" diameter brass wire. Apply ACC to the bottom of the support wires from the inside of the car body.

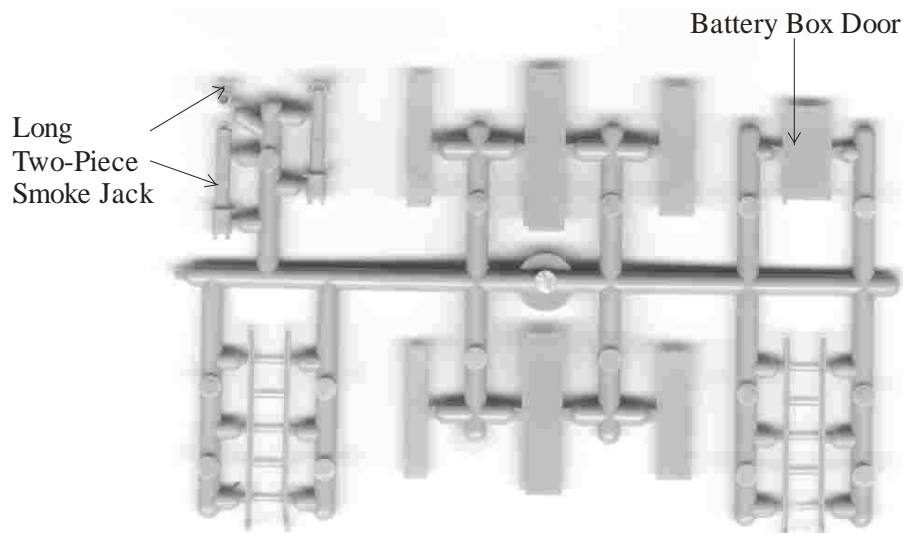

Step 20. Add the battery box door to the three-window side of the car, if modeling this detail.

Step 21. Attach the marker light brackets.

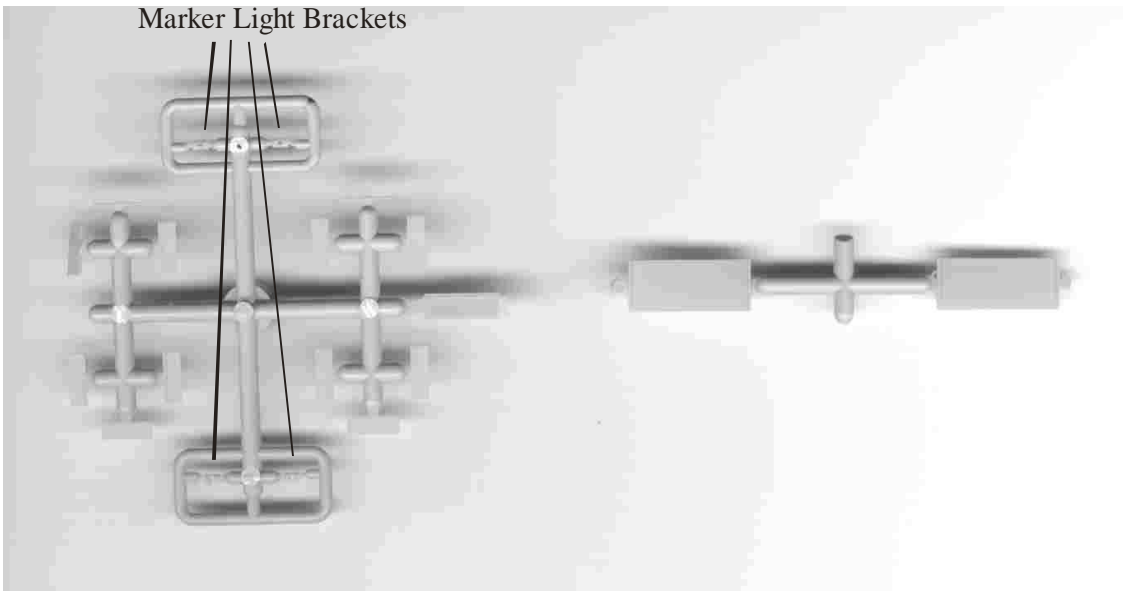

Step 22. Mask the window and door openings from the inside prior to painting the outside of the carbody.

Step 23. The kit includes two types of wood roof walks; one version with walks half across at the cupola (ACL - alternate cupola laterals), one version with walks across the full width at the cupola (FCL – full cupola laterals). When modeling waycars 2101-2200 as built, WEL – wide end lateral roof walks must be built from scratch. The kit also includes metal roof walks which replaced the wood roofwalks eventually. Choose the roof walks for the car and paint them prior to assembly.

CUPOLA

Step 24. Clear the grab iron holes with a .016 in. dia. (#78) drill. If the car is modeled with the cupola roof antenna, open the four holes for the etched metal ground plane from the underside of the cupola roof with a .021 in. dia. (#75) drill.

Step 25. Attach the cupola roof grab iron using the metal eyelets.

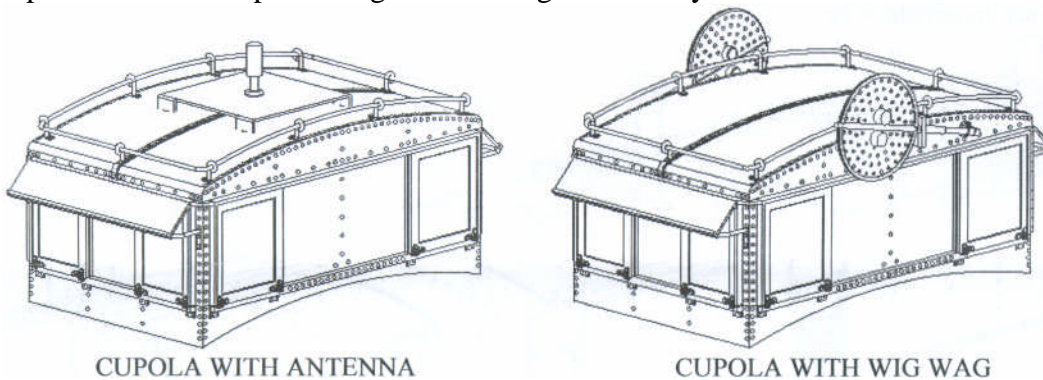

Step 26. Attach the sun shades to the sides of the caboose. The wire support inserts into the holes at each corner of the cupola. The angled edge of the shade contacts the flange across the top of the side windows and rests on the wire support.

Step 27. If the car is modeled with the antenna, attach the etched metal antenna ground plane to the top of the cupola, and the 'firecracker' antenna into the hole in the center of the ground plane. Note that the body should have the battery box door if the car is modeled with the antenna.

Step 28. Mask the cupola windows from the inside prior to painting the outside.

Step 29. There are two types of tool cellars in the kit; wooden version and steel version. Determine which tool cellar for assembly to the car and assemble the pair. Do not attach them to the locator holes in the bottom of the floor at this time. .

Step 30. Paint floor and frame assembly, toolcellars and outside of carbody and cupola. Letter car with Microscale MC-4401 decals.

Step 31. Paint the wig wag signals if modeling this detail. Attach the wig wag signals to the cupola. The wig wag signals are included in the kit. The wig wag base is the small round disk that attaches to the surface of the end of the cupola, above the inside vertical of the window to the right. The end of the wig wag bar attaches to the base, and the rectangular bracket attaches to the top center of the end of the cupola.

FINAL ASSEMBLY

Step 32. Attach clear windows to carbody and cupola. The mullions molded into the end door windows should be to the outside.

Step 33. Paint stainless steel window screens and attach them to carbody

Step 34. Attach tool cellars to locator holes in the bottom of the floor.

Step 35. Attach weight to the top of the floor with epoxy adhesive. Do not use ACC for this glue joint.. Glue the body onto the floor.

Step 36: Attach trucks and couplers

Step 37. Attach the ladders to the ends, against the locators on each end beam, and into the locator holes in the edge of the roof.

Step 38. Attach the safety whistles along side each ladder.

Step 39. Attach the grab iron loops from the ladders to the roof walks, and the grab irons to the end beams.

Step 40. Snap the cupola into position on the roof.

Step 41. Hand-paint previously unpainted details like ladders etc.

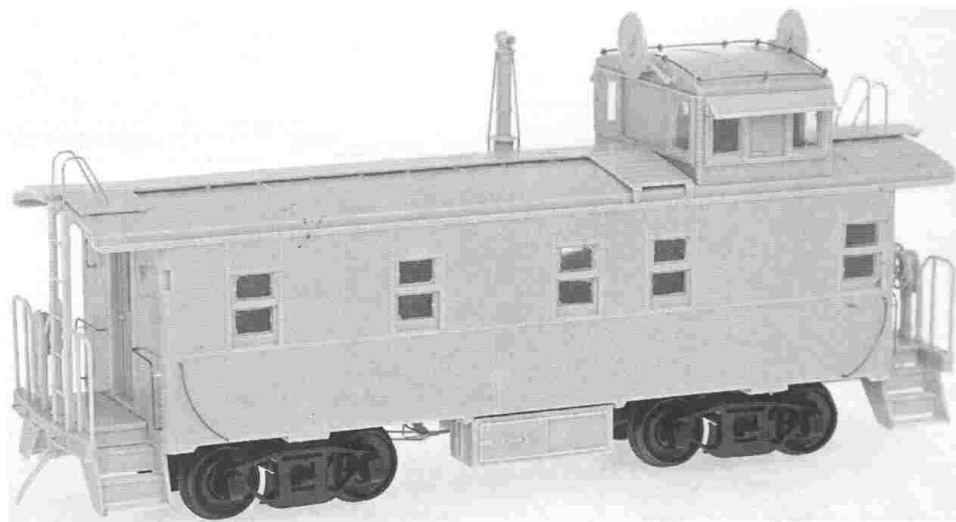
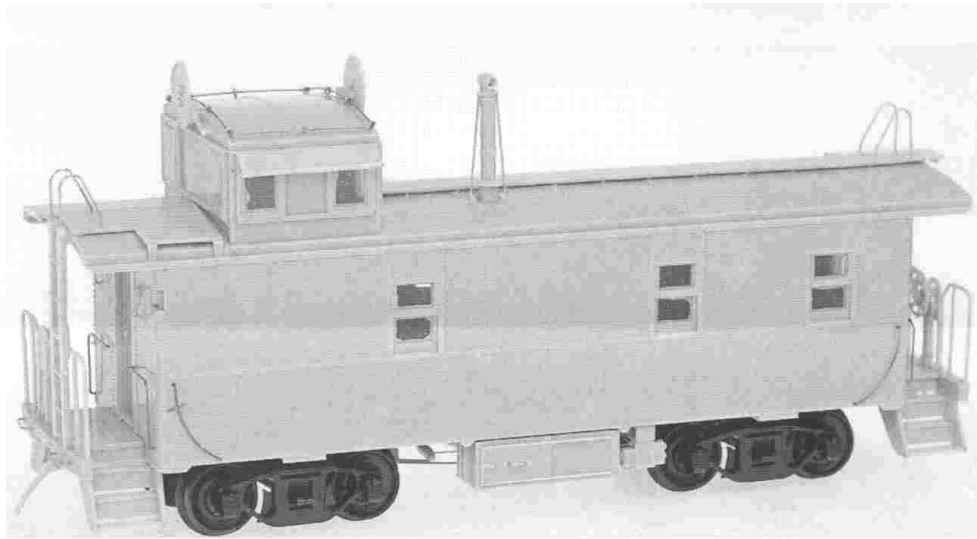

Enhancements

ALL METAL WHEELSETS

While ready-to-run models of the waycars are delivered with all brass wheelsets, only plastic wheelsets are provided in the kits. It is recommended to replace the plastic wheelsets with InterMountain or Reboxx 33" all brass wheelsets.

ELECTRICAL PICKUP FOR INTERIOR LIGHTING AND/OR ILLUMINATED MARKER LIGHTS

The following steps are only necessary if the car interiors and/ or marker lights shall be illuminated and the car must be disassembled for electrical installation or service.

After Step 4. Tap both trucks bolsters with imperial 2-56 or metric M2 threads. Insert 1-1/8" long 2-56 or M2 threaded rod into each bolster such that they extend 1/8" below the truck bolster. Secure threads with ACC.

Attach car weight with 2-56 or M2 washers and nuts.

For imperial screws: Drill 4 holes with # 48 or 1.9mm drill through floor and car weight. Drill in 2 steps: Drill all 4 holes through the floor and just enough into the car weight to mark the holes. Then remove the car weight from the floor and drill through the car weight. See sketch below for exact location of holes

For metric screws: Drill 4 holes with # 53 or 1.5mm drill through floor and car weight. Drill in 2 steps: Drill all 4 holes through the floor and just enough into the car weight to mark the holes. Then remove the car weight from the floor and drill through the car weight. See sketch below for exact location of holes.

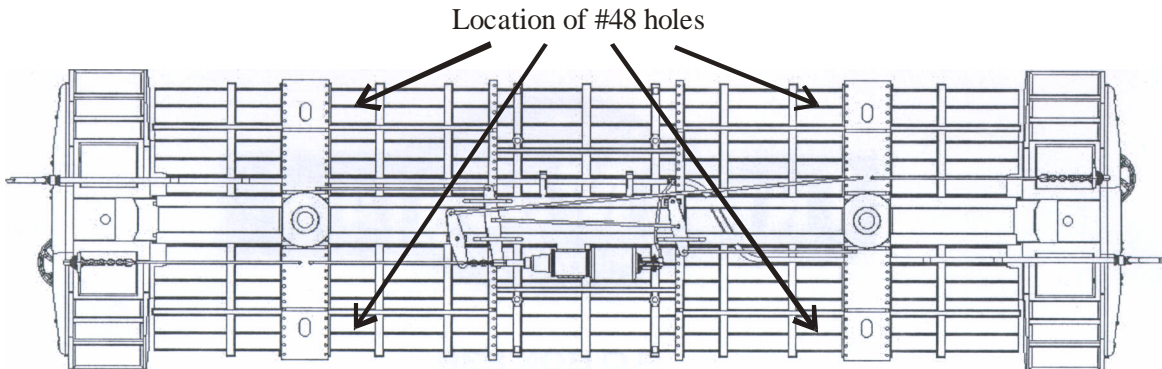

Glue 4 3/4" long pieces of .060" x .156" strip styrene into car body. Use Plastruct Plastic Weld for this glue joint. See sketch below for exact location of strip styrene.

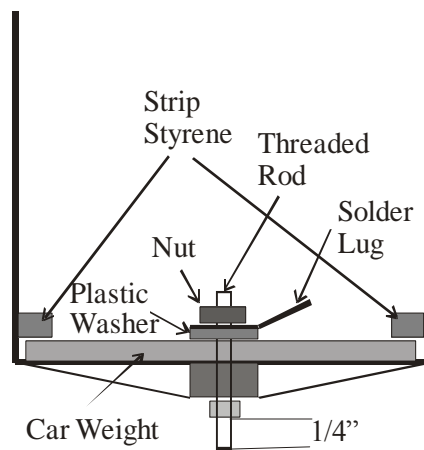

Re-assemble floor and car weight and fit them into car body. Drill with #48 or 1.9mm (#53 or 1.5mm for metric screws) drill through floor and car weight deep enough into styrene strips to mark holes. Disassemble floor, car weight and car body and drill marked holes through styrene strips with #54 or 1.4mm (#57 or 1.1mm for metric screws) drill. Tap holes with imperial 1-72 or metric M1.4 threads. Set car weight and car body aside. Light bulbs or LEDs and all electronic circuitry should be installed prior to final assembly. Car body should not be glued to floor and underframe as described in step 35 but attached with 1-72 or M1.4 screws instead.

AMB LASERKIT WINDOWS SCREENS

Several modelers have recommended to replace the etched stainless steel window screens provided in the InterMountain kit with AMB Laserkit frames and screen material . Follow the assembly instructions provided with the AMB Laserkit #225 window screen material.

SERIES 2001-2200 ENHANCEMENTS

Trucks : Replace the InterMountain trucks provided in the kit with Tahoe Model Works # 105 Barber-Bettendorf Swing Motion trucks (or #205 trucks with "semi-scale" wheelsets)
 Additional bottom side panel separations: Work in process, will be added later.

ILLUMINATED MARKER LIGHTS

Work in process, will be added later.

MATERIAL LIST

InterMountain	Santa Fe Early Steel Caboose Undecorated CCS1199
Kadee	#78 Couplers
Detail Associates	Round Brass Wire -- .012" Diameter (HO Scale 3/4") 229-2504
Microscale Decals	MC-4401 ATSF
Satellite City	Hot Stuff Super T (or equivalent)
Plastruct	Plastic weld (or equivalent)

OPTIONAL

InterMountain	33" All-Brass Insulated Wheelsets
Evergreen Scale Models	StripStyrene #157 .060 x .156
Smallparts.com	Threaded rod 2-56 or M2
Smallparts.com	Nylon washers #1 or 2.15mm ID
Smallparts.com	Hex Nuts 2-56 or M2
Smallparts.com	Pan- or Cheese-Head screws 1-72 or M1.4
AMB Laserkit	#225 Window Screen Material
Tahoe Model Works	#105 Barber-Bettendorf Swing Motion trucks

ACKNOWLEDGEMENTS:

I would like to thank Steve Sandifer for his numerous suggestions and his help to sort out contradictory information about the paint schemes of the cars. I would also like to thank Frank Angstead, President of InterMountain Railway Co for his permission to use printed material supplied in the InterMountain assembly instructions.

I wrote these instructions while I built my first caboose model, waycar #1551. As I will be building different versions of the cars in future; I plan to edit and update these instructions. Since the available information is partially contradictory I took a „best guess“ approach which may be incorrect. So any questions, suggestions and corrections are highly welcome. Please contact me at [peteraue \(at\) yahoo.de](mailto:peteraue@yahoo.de)